







EM9580 C - EM9580 LaserLine *plus* LaserLine *plus*

-  Smart Arm *plus*
-  Laser Line
-  Led Light
-  WM WEIGHT MANAGEMENT Integrated Software Suite
-  AWD OPT



- 
- 
- 

WiNut Locking Version



EM9580 C - EM9580 LaserLine plus LaserLine

NEW



1

Funzione FSP e laserblade
FSP and laserblade function



2

Posizionamento automatico
e illuminatore led
Automatic positioning
and led illuminator



3

Applicazione contrappesi adesivi
Application of adhesive counterweights



4

Rilevatore AWD
AWD - auto width device

NEW



5

Winut - bloccaggio automatico
wireless
Winut - wireless automatic
clamping system



6

Portapesi e tastiera navisystem
Wheight tray and navisystem keyboard



8

Porte usb
Usb ports



7 PROGRAMMI PER IL PROFESSIONISTA - PROGRAMME FOR THE PROFESSIONAL



Weight management
Weight management



Ottimizzazione squilibrio
Imbalance optimization



Calibrazione semplificata
Easy cal



AWC calcolo automatico
della larghezza
AWC - auto width
Calculation



9

Frontale inclinato e carter ruota salvaspazio
Inclined front side and space-saving wheel guard

1 RILEVAMENTO DIMENSIONI RUOTA CON SMART ARM PLUS - WHEEL DIMENSION DETECTION WITH SMART ARM PLUS

Nuovo calibro digitale per l'acquisizione del diametro e della distanza con funzione **FSP (Fast Selection Program)** e **nuovo puntatore LaserBlade integrati**: la funzione FSP attiva automaticamente i programmi di equilibratura evitando così le selezioni da tastiera, mentre il puntatore LaserBlade (all'interno braccetto di misura) guida l'operatore nella scelta dei piani interni del cerchio in lega senza errori e con estrema visibilità.

Veloce • Elimina gli errori di misura • Guida l'operatore • Estrema visibilità, rapidità e precisione • Massima scorrevolezza

New digital gauge for the acquisition of the diameter and distance with the **FSP (Fast Selection Program) function and new integrated LaserBlade**

pointer: the FSP function automatically activates the balancing program avoiding selection via the keypad, while the LaserBlade pointer (inside the measuring arm) guides the operator in choosing the level within the alloy rim without any errors and with extremely good visibility.



Fast • Eliminates measurement errors • Guides the operator • Extremely good visibility, quick and accurate • Optimum flow

2 POSIZIONAMENTO AUTOMATICO E ILLUMINATORE LED - AUTOMATIC POSITIONING AND LED LIGHT



A fine lancio la ruota viene frenata e portata automaticamente in posizione di equilibratura (RPA). L'illuminatore led integrato illumina l'area di lavoro per facilitare le operazioni di pulizia del cerchione e l'applicazione dei contrappesi

At the end of the spin the wheel is braked and automatically brought to the balancing position. The integrated LED light illuminates the work area to facilitate rim cleaning and application of the counterweights

3 APPLICAZIONE CONTRAPPESI ADESIVI - APPLICATION OF ADHESIVE COUNTERWEIGHTS

I contrappesi adesivi possono essere posizionati con estrema velocità utilizzando il puntatore laser a ore 6 (laser line system) o tramite l'utilizzo della clip portapesi

The adhesive counterweights can be positioned extremely rapidly using the laser pointer at 6 o'clock (laser line system) or by using the weight tray clip



Software: LPS - Laser Line System

4 RILEVATORE AWD - AWD MEASURING SENSOR

Rilevatore AWD (Auto Width Device) per la misura automatica della larghezza ruota senza contatto con sensore sonar (optional).

AWD automatic sensor (Auto width Device) for contactless measurement of wheel width (optional)

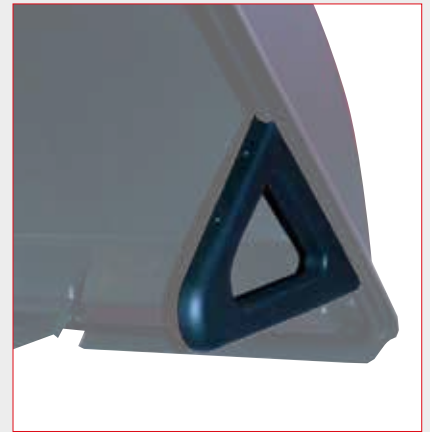

5 BLOCCAGGI RUOTA DISPONIBILI - AVAILABLE WHEEL CLAMPING

A **Winut** - Basta una semplice pressione sul tasto del manico per essere più veloci e lavorare comodamente.

Non usi più il piede per comandare il sistema di bloccaggio automatico.

B Nuovo **sistema automatico elettromeccanico** di bloccaggio ruota che riduce i tempi lavoro e incrementa la precisione di centraggio (EM9580 C), oppure bloccaggio ruota **manuale con ghiera rapida** (EM9580) **C**.

A **Winut** - Simply press the button on the sleeve to lock quicker and with less effort than before.

No need to use your foot to operate the automatic clamping system.

B New **electromechanical system** which reduces working times and increases centring precision (EM9580 C), or **manual wheel clamping** with quick ring (EM9580) **C**.

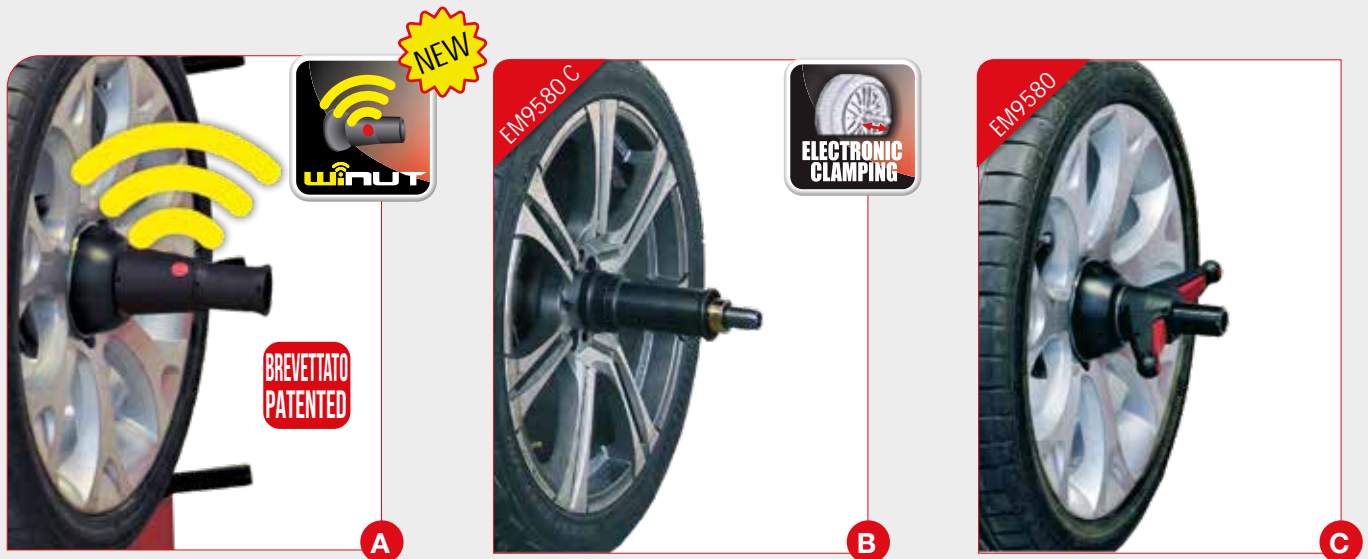

6 PORTAPESI E TASTIERA NAVISYSTEM - WEIGHT TRAY AND NAVISYSTEM KEYBOARD

Pianale portapesi ergonomico e funzionale, dotato di ampie vaschette per le diverse tipologie di contrappesi e il posizionamento degli utensili. I comandi e la navigazione nei menu risulta veloce e semplice. Basta un clic per accedere direttamente ad ogni programma.

Weight tray ergonomic and functional, it features many large trays to house all different types of counterweights and the various tools. NaviSystem. Controls and menu navigation are quick and easy. Just a click to directly access each programme.

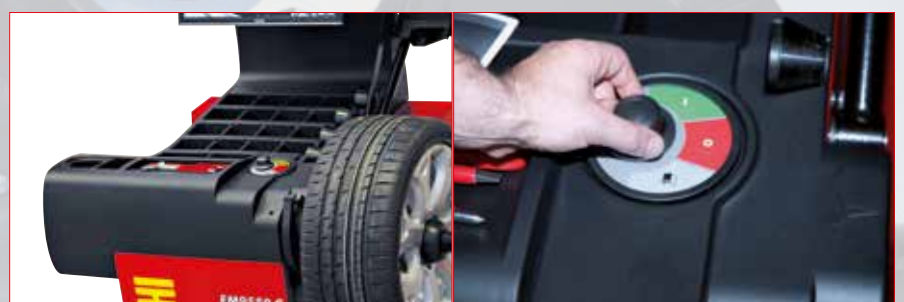

PROGRAMMI PER IL PROFESSIONISTA - PROGRAMME FOR THE PROFESSIONAL

Tutti i programmi per il professionista: OPT FLASH, HIDDEN WEIGHT, SPLIT WEIGHT, MULTIOPERATORE visualizzati su Monitor widescreen, orientabile, con grafica ad elevata risoluzione e con semplice interfaccia utente.

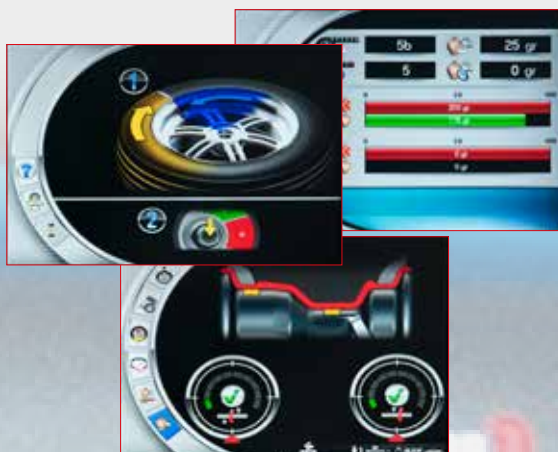

Every programme for the professional: OPT FLASH, HIDDEN WEIGHT, SPLIT WEIGHT, MULTIOPERATOR, visualized on the widescreen monitor with high-resolution graphics and user interface.



PESO NASCOSTO HIDDEN WEIGHT

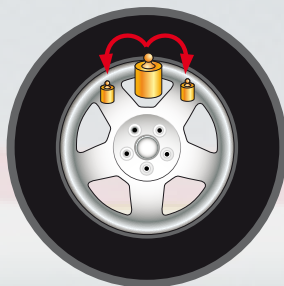

Perfetta estetica del cerchio perchè permette di dividere il peso adesivo di equilibratura del fianco esterno in due pesi equivalenti collocati in posizione nascosta dietro le razze.
Keeps rims looking great by dividing the external side balancing adhesive weight into two equivalent weights applied in hidden locations behind the spokes.



OPT FLASH

Massima silenziosità di marcia perchè permette di ottimizzare la silenziosità variando la posizione del pneumatico sul cerchio.

Minimises road noise by allowing the operator to alter the position of the tyre on the rim in order to optimise quietness.



WEIGHT MANAGEMENT

Speciale raccolta di programmi tra cui il LESS WEIGHT che permette di ridurre i tempi di lavoro

(20%) e la quantità di contrappesi utilizzati (30%) incrementando i benefici economici e la salvaguardia dell'ambiente.

Special programme collection including LESS WEIGHT which reduces work times (20%) and the amount of counterweights used (30%), increasing the economic benefits and environmental protection.



AWC - CALCOLO AUTOMATICO DELLA LARGHEZZA AWC - AUTO WIDTH CALCULATION

Calcolo automatico della larghezza ruota (Funzione AWC) anche in assenza del sensore esterno AWD. L'equilibratrice fa una previsione della larghezza ruota riducendo i tempi operativi.

Reduced wheel data entry times thanks to the AWC function which suggests the most probable width value (in the absence of the AWD measuring sensor).

8 PORTE USB - USB PORTS

Porte USB per il collegamento alle periferiche e l'aggiornamento software semplificato

USB ports for connection to peripheral devices and easy software upgrading



9 FRONTALE INCLINATO INCLINED FRONT PART

Frontale inclinato per incrementare l'accesso dell'operatore all'area interna del cerchio

Inclined front part to improve operator access to the inside of the rim

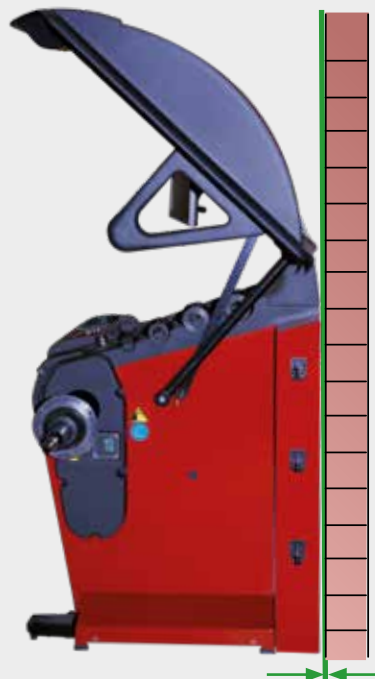

CARTER RUOTA SALVASPAZIO SPACE-SAVING WHEEL CASING

Carter ruota salvaspazio (brevettato) studiato per permettere il posizionamento a muro dell'equilibratrice e per accogliere ruote fino ad un diametro massimo di 44" (1.118 mm)

Space saving wheel guard (patented) designed to allow the positioning along the wall, it also permits to hold wheels up to 44" (1.118 mm) maximum diameter

SOLLEVATORE RUOTA - WHEEL LIFTER

Predisposta per il collegamento diretto ai sollevatori ruota TT-0 (automatico) e TT-R (manuale) che annullano lo sforzo dell'operatore, velocizzano le operazioni quotidiane e garantiscono un centraggio perfetto.



Predisposed for direct connection to the new TT-0 wheel lifter which eliminates operator effort, speeds up routine operations and ensures perfect centring



DATI TECNICI

Tensione di alimentazione	115÷230 V 1ph 50/60 Hz
Potenza complessiva assorbita	400 W
Velocità di equilibratura	75-85-98 rpm
Massimo valore di squilibrio	999 g 35,3 oz
Risoluzione	1 g 0,0353 oz
Tempo medio di misura	(ruota da 14kg) 5,5 s
Diametro albero	40 mm 1,57"
Larghezza cerchio impostabile	1,5" ÷ 20"
Diametro cerchio impostabile	1" ÷ 35"
Diametro cerchio misurabile	10" ÷ 28"
Larghezza massima ruota (con protezione)	600 mm 23,6"
Diametro massimo ruota (con protezione)	1118 mm 44"
Distanza massima ruota/macchina	275 mm 10,82"
Frequenza di lavoro dispositivo WINUT	2.4 GHz
Potenza massima del segnale a radiofrequenza	100mW
Peso ruota	85 Kg
Peso macchina	140 kg
Dimensioni massime l x p x h	1453 x 894 x 1858 mm



TECHNICAL DATA

Power supply voltage	115÷230 V 1ph 50/60 Hz
Total power absorption	400 W
Balancing speed	75-85-98 rpm
Maximum unbalance value	999 g 35,3 oz
Resolution	1 g 0,0353 oz
Average measurement time	(14kg wheel) 5,5 s
Shaft diameter	40 mm 1,57"
Rim width setting range	1,5" ÷ 20"
Rim diameter setting range	1" ÷ 35"
Rim diameter measurement range	10" ÷ 28"
Maximum wheel width (with guard)	600 mm 23,6"
Maximum wheel diameter (with guard)	1118 mm 44"
Maximum wheel/machine distance	275 mm 10,82"
WINUT device operation frequency	2.4 GHz
Maximum power of the radiofrequency signal	100mW
Maximum wheel weight	85 Kg
Machine weight	140 kg
Maximum dimensions l x p x h	1453 x 894 x 1858 mm

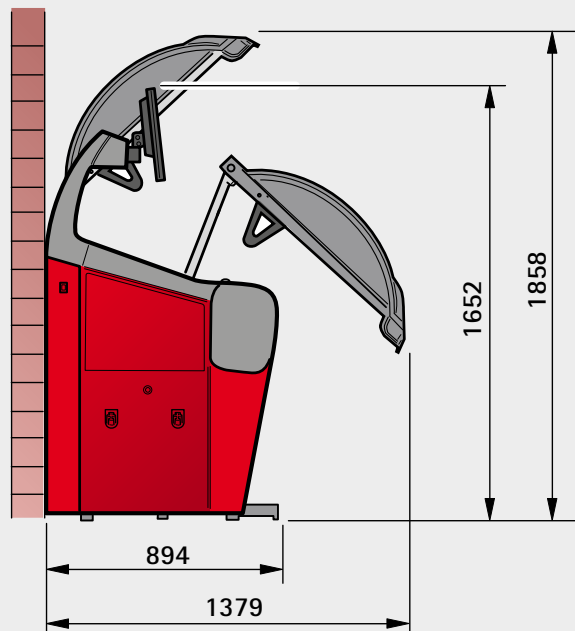
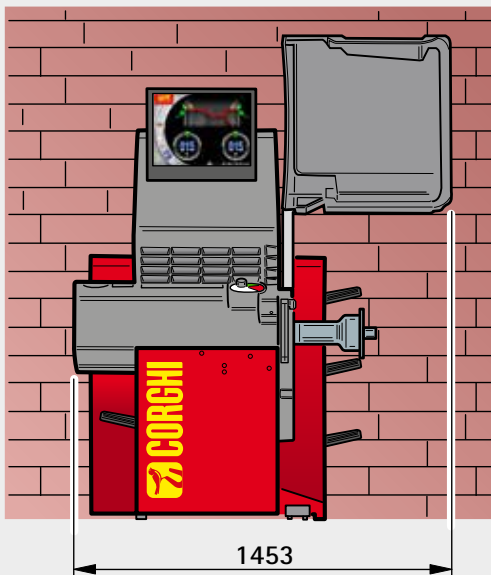

VERSIONI
VERSIONS

EM9580 C PLUS
Bloccaggio Ruota Automatico
Automatic Locking Version

NEW

EM9580 C PLUS
Bloccaggio Ruota WiNut
WiNut Locking Version

EM9580 PLUS
Con bloccaggio ruota manuale
With manual locking system

AUTOMATIC
LOCKING SYSTEM



WiNUT
LOCKING SYSTEM



MANUAL
LOCKING SYSTEM



ACCESSORI CONSIGLIATI - RECOMMENDED ACCESSORIES

A 8-21100253/16
Colonna di supporto RAL 3002 per 8 boccole bifronte HPC
*Per equilibratrici di colore diverso dal colore standard RAL 3002, utilizzare il codice 8-21100253/90



Support panel for HPC High Precision Collets centering kit
*For balancers in color other than standard RAL 3002, please use: PN. 8-21100253/90

B 8-21100244
HPC Set di 8 boccole bifronte a bassa conicità e alta precisione
HPC High Precision Collets, 8 two-faced slightly tapered bushings



C 8-21100251
Kit dispenser per contrappesi adesivi
Dispenser kit for coil of adhesive weights



D 8-21100252
Bobina contrappesi adesivi. Rotolo in ferro (5 g x 1200 pz)
Coil of adhesive weights. Iron roll (5 g x 1200 pz)



E 8-21100232
Rilevatore della larghezza AWD
AWD automatic sensor

F 8-21100145
FPF-2 BMW Flangia omologata per ruote BMW
FPF - 2 BMW Universal flange kit for wheels with central hole



G 8-21100141
DX/CBF Accessorio di centraggio per furgoni e fuoristrada con foro centrale Ø 117÷173 mm
DX/CBF Centring accessory for van and off-road wheels with central hole with Ø 117÷173 mm



H 8-21100235 Monitor LCD 19" / LCD Monitor 19"
8-21100234 Monitor LCD 22" / LCD Monitor 22"



I SOLLEVATORI RUOTA TT-Ø (COD. 8-21100230) e TT-R (COD. 8-21100248)
Sollevatori ruota "effetto senza peso" TT-Ø (automatico) e TT-R (manuale) che annullano lo sforzo dell'operatore, velocizzano le operazioni quotidiane e garantiscono un centraggio perfetto
TT-Ø (COD. 8-21100230) and TT-R (COD. 8-21100248) WHEEL LIFTING DEVICES
"Weightless effect" TT-Ø (automatic) and TT-R (manual) wheel lifters which eliminate operator effort, speed up routine operations and ensure perfect centring

Per maggiori informazioni consultare il catalogo accessori completo
For more information, please consult the accessories catalogue.



EM9580 Video



EM9580 Video



EM9580 Video

Fotografie, caratteristiche ed i dati tecnici non sono vincolanti, possono subire modifiche senza preavviso.
The manufacturer reserves the right to modify the features of its products at any time.
Cod. DPC001089B 01/2022

Per aiutare il pianeta ottimizzando il consumo di carta, i nostri cataloghi sono consultabili sul sito www.corghi.com. Una stampa responsabile aiuta a preservare l'ambiente. To protect the planet and reduce paper usage, our catalogues are viewable online at the website www.corghi.com. Printing responsibly contributes to saving the environment.



NEXION SPA - www.corghi.com - info@corghi.com

